

Equerres, tés

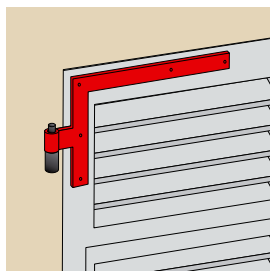

S9005.. Equerre bout carré
35x4 Ø14

Code gauche	Code droite			Dispo. (sem.)
S900514Z	S900528Z	316L	1	STOCKÉ
S900514	S900528	316L B	1	STOCKÉ

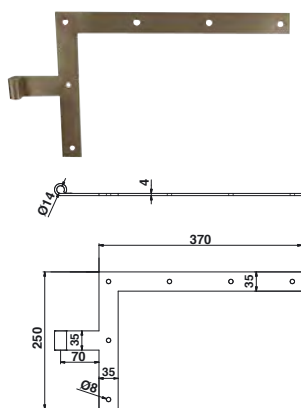
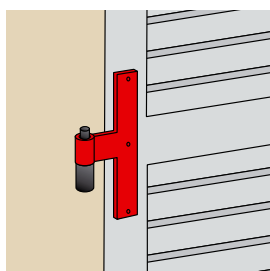
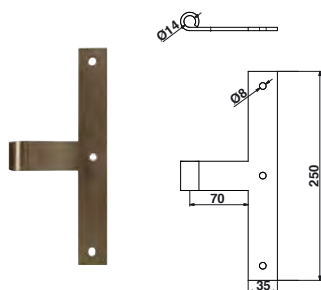

S90061.. Té de milieu
35x4 Ø14

Code			Dispo. (sem.)
S900614Z	316L	1	STOCKÉ
S900614	316L B	1	STOCKÉ

Gonds

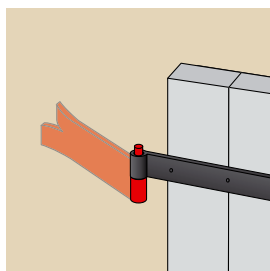
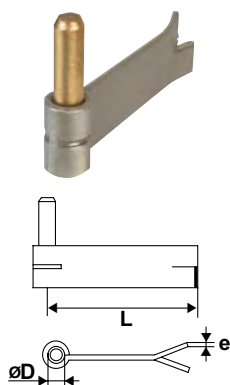

S90114.. Gond à sceller 1 lame axe laiton

Code		ØD	L	e		Dispo. (sem.)
S901146Z	316L	16	180	5	1	2
S901144	316L B	14	135	4	1	2
S901146	316L B	16	180	5	1	2

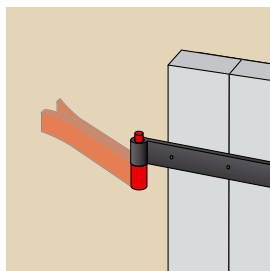
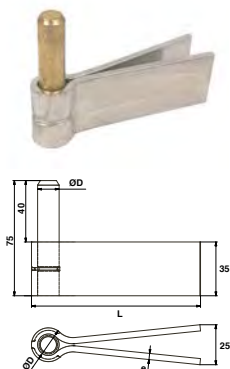

S90124.. Gond à sceller 2 lames axe laiton

Code		ØD	L	e		Dispo. (sem.)
S901244Z	316L	16	110	4	10	2
S901246Z	316L	16	120	5	1	2
S901244	316L B	14	110	4	1	2
S901246	316L B	14	120	5	1	2

Gonds

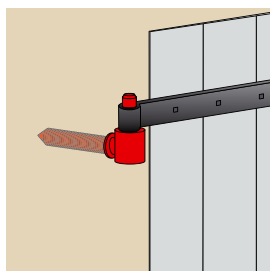
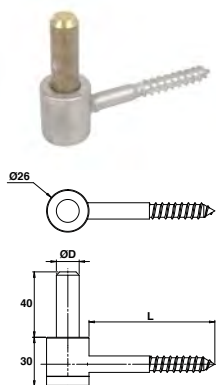

S90041.. Gond vis bois axe laiton

Code		ØD	L		Dispo. (sem.)
S900414Z	316L	14	80	1	STOCKÉ
S900414	316L B	14	80	1	STOCKÉ
S900416	316L B	16	80	1	STOCKÉ

Code		ØD	L		Dispo. (sem.)
S900417	316L B	14	107	1	2
S900417Z	316L	14	107	1	2

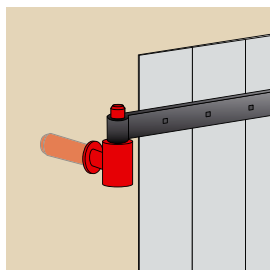
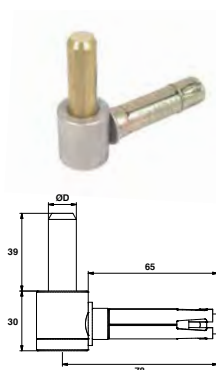

S90141.. Gond vis métaux + cheville axe laiton

Code		ØD		Dispo. (sem.)
S901414	316L B	14	10	STOCKÉ

Code		ØD		Dispo. (sem.)
S901416Z	316L	16	1	2

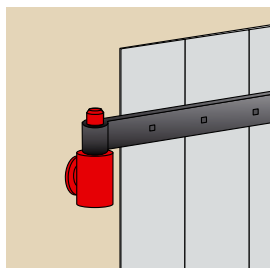
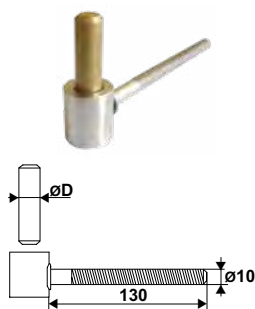

61IX1.. POLYGOND® axe laiton

Code		ØD		Dispo. (sem.)
61IX14Z	316L	14	10	STOCKÉ
61IX14PB	316L B	14	10	STOCKÉ
61IX16PB	316L B	16	10	STOCKÉ

Code		ØD		Dispo. (sem.)
61IX16Z	316L	16	10	4

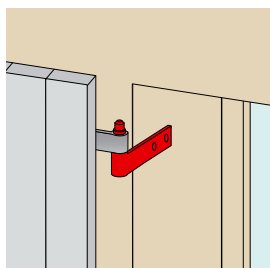
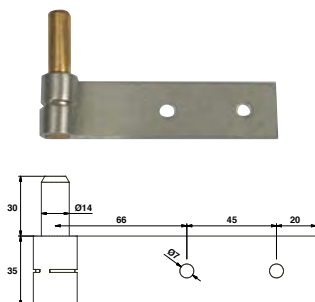

S901088Z Gond à patte 35x4 Ø14 axe laiton

Code			Dispo. (sem.)
S901088Z	316L	10	STOCKÉ

Gonds

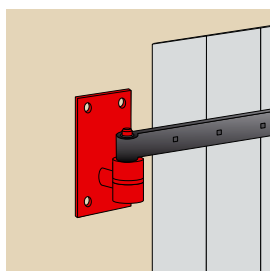
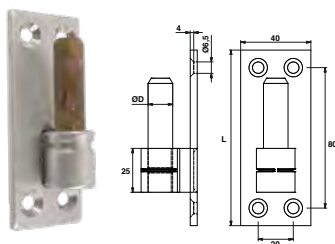

S90131.. Gond sur plaque axe laiton

Code	Color	ØD	L	Dispo. (sem.)	
S901314Z	316L	Ø14	100	1	STOCKÉ
S901316Z	316L	Ø16	180	10	STOCKÉ
S901314	316L B	Ø14	100	1	STOCKÉ

Code	Color	ØD	L	Dispo. (sem.)	
S901316	316L B	Ø16	180	1	4

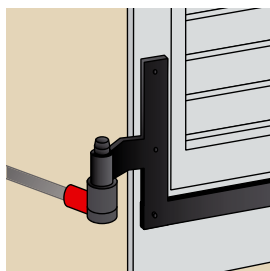
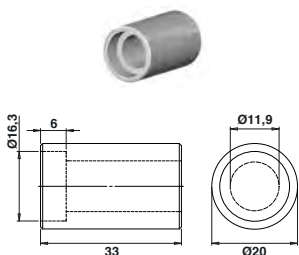

S900450 Entretoise pour Polybond®

Code	Color	L	Dispo. (sem.)
S900450	316L	150	STOCKÉ

Tourniquets

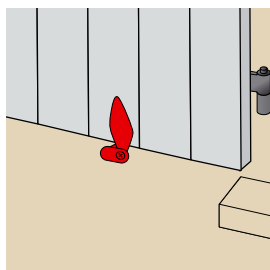

S90151.. Tourniquet marseillais à vis * tête forgée

Code	Color	L	Dispo. (sem.)	
S901513Z	316L	130	10	STOCKÉ
S901513	316L B	130	1	STOCKÉ

Code	Color	L	Dispo. (sem.)	
S901510Z	316L	110	10	2
S901518Z	316L	180	10	2
S901510	316L B	110	1	2
S901518	316L B	180	10	2



La mise en œuvre des fermetures est encadrée par le DTU 34-4, s'y référer pour éviter tout danger.

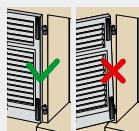

Bien s'assurer que le vantail soit monté plaqué et serré sur la façade.



En cas de vent, fermer les volets.



Pour les volets de grandes tailles, utiliser uniquement les arrêts adaptés



Conseils de pose P.113



Plus d'infos sur www.torbel.fr

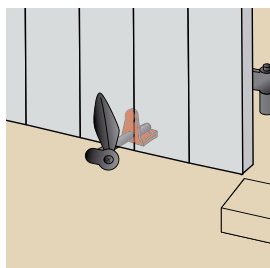
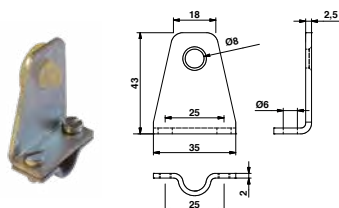

S901525 Butée pour tourniquet marseillais Ø10

Code	Color	L	Dispo. (sem.)
S901525	316L	1	STOCKÉ