

Equerres, tés

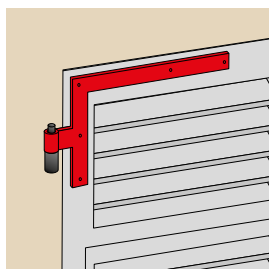

S9005.. Equerre bout carré  
35x4 Ø14

Code gauche	Code droite		Tarif HT en €		Dispo. (sem.)
S900514	S900528	316L B	68,30	1	STOCKÉ
S900514Z	S900528Z	316L P	62,82	1	STOCKÉ

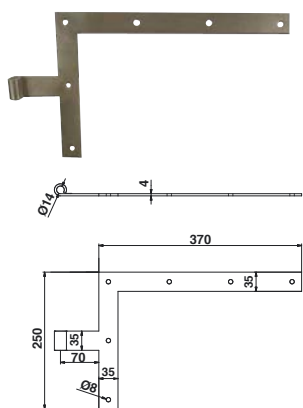
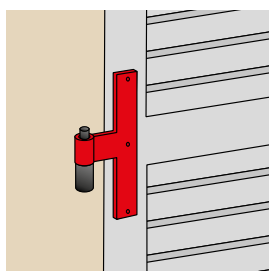
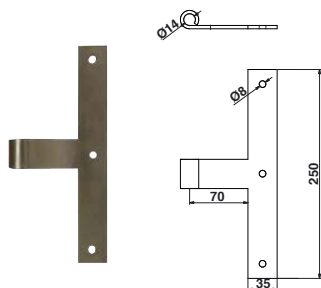

S90061.. Té de milieu  
35x4 Ø14

Code		Tarif HT en €		Dispo. (sem.)
S900614	316L B	41,79	1	STOCKÉ
S900614Z	316L P	38,44	1	STOCKÉ

Gonds

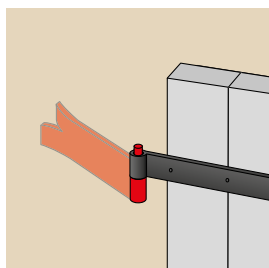
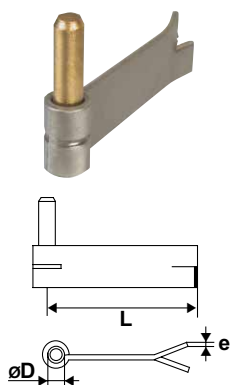

S90114.. Gond à sceller 1 lame axe laiton

Code		L	ØD	e	Tarif HT en €		Dispo. (sem.)
S901144	316L B	135	14	4	Nous consulter	1	2
S901146	316L B	180	16	5		1	2
S901146Z	316L P	180	16	5		1	2

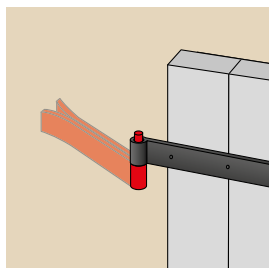
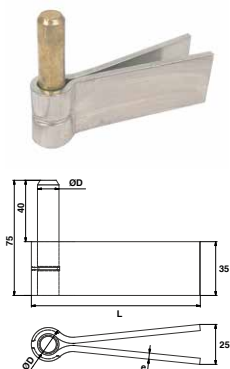

S90124.. Gond à sceller 2 lames axe laiton

Code		ØD	L	e	Tarif HT en €		Dispo. (sem.)
S901244Z	316L P	14	110	4	28,41	10	STOCKÉ
S901246Z	316L P	16	120	5	30,87	1	STOCKÉ

Code		ØD	L	e	Tarif HT en €		Dispo. (sem.)
S901244	316L B	14	110	4	Nous consulter	1	2
S901246	316L B	16	120	5	Nous consulter	1	2