

Fléau de volet

Code		L		Dispo. (sem.)
G903516	316L B	150	10	1

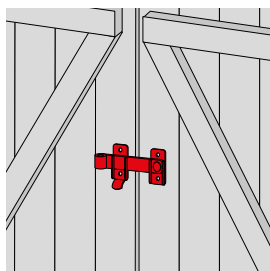
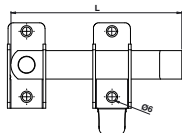

Fléau de volet et support à tirer

Code		L		Dispo. (sem.)
G918120	316P	120	10	1

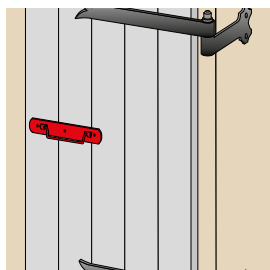
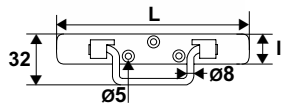

Poignée sur platine «St Etienne» bouts ronds

Code		L	I		Dispo. (sem.)
G900114	316P	140	25	10	1

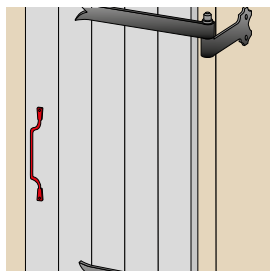
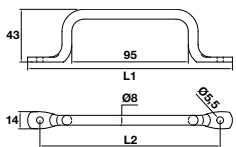

Poignée à pattes

Code		L1	L2		Dispo. (sem.)
G900118	316P	167	147	10	1