

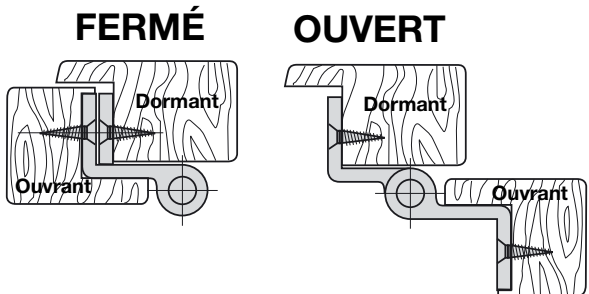

Modèle gauche

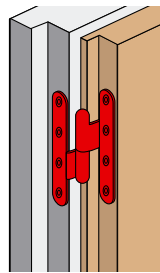

Modèle droite

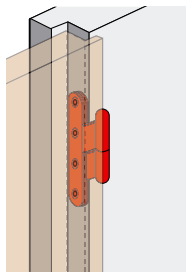

**J53.. Paumelle bouts ronds à bague coudée**

Code Sens gauche	Code Sens droite		Dim	Coudage	Poids		Dispo. (sem.)
J532740	J532710	Z.BLANC	110 x 60 x 70 NF	100°	0,151	12	STOCKÉ
J532660	J532630	Z.BLANC	110 x 60 x 70 NF	90°	0,151	12	STOCKÉ
J532800	J532790	Z.BLANC	110 x 70 x 80 NF	90°	0,175	12	STOCKÉ
J532930	J532920	Z.BLANC	140 x 60 x 70 NF	100°	0,216	12	STOCKÉ
J532970	J532940	Z.BLANC	140 x 60 x 70 NF	90°	0,180	12	STOCKÉ
J533010	J533000	Z.BLANC	140 x 70 x 80 NF	90/100°	0,237	12	STOCKÉ
J533039	J533019	Z.BLANC	160 x 70 x 80	100°	0,267	12	STOCKÉ



Modèle gauche



Modèle droite

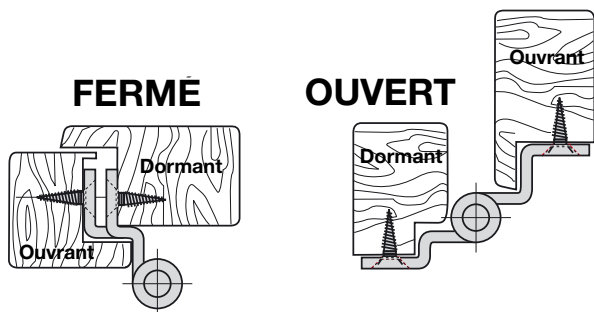
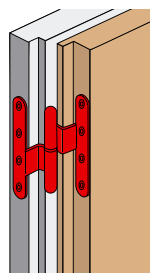
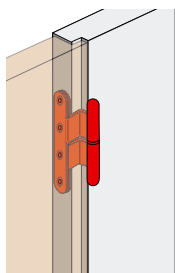

**J5328.. Paumelle bouts ronds contrecoudée 90°**

Code Sens gauche	Code Sens droite		Dim	Poids		Dispo. (sem.)
J532820	J532810	Z.BLANC	110 x 70 x 80 NF	0,175	12	4

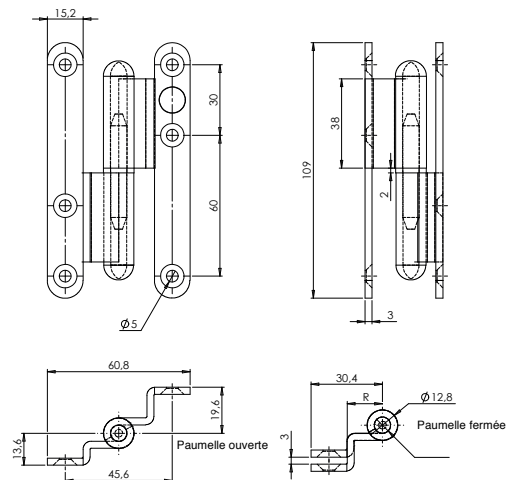

**i** Plans et dimensions : voir P.604  
Graisser l'axe lors de l'installation et régulièrement. Visserie non fournie.