

S9035.. Fléau de volet

Code		L		Dispo. (sem.)
S903516	316L B	150	1	STOCKÉ

Code		L		Dispo. (sem.)
S903520	316L B	200	1	2

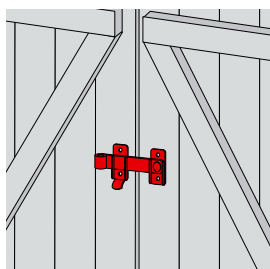
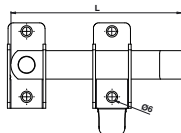

S918120 Fléau de volet et support à tirer

Code		L		Dispo. (sem.)
S918120	316L	120	10	Nous consulter

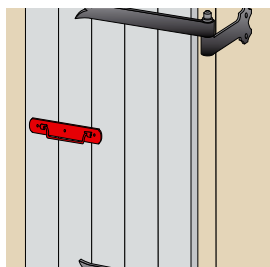
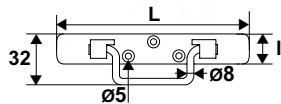

S900114 Poignée sur platine «St Etienne» bouts ronds

Code		L	l		Dispo. (sem.)
S900114	316L B	140	25	1	STOCKÉ

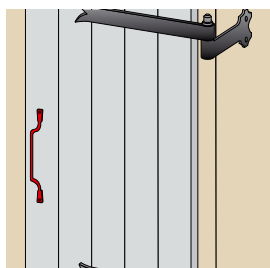
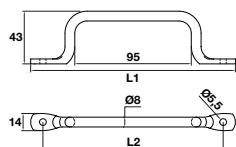

S900118 Poignée à pattes

Code		L1	L2		Dispo. (sem.)
S900118	316L PS	167	147	5	STOCKÉ

Poignées, agrafes picardes, gâche

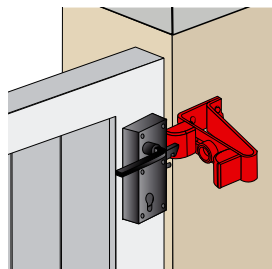
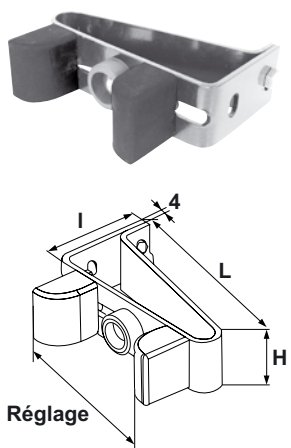
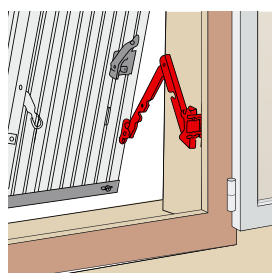
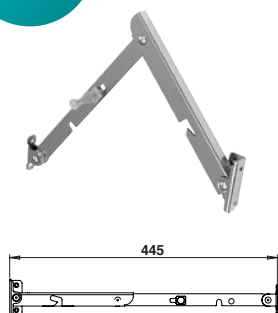
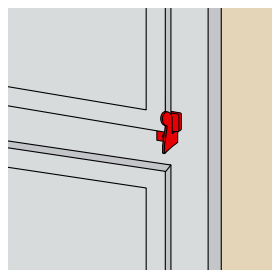
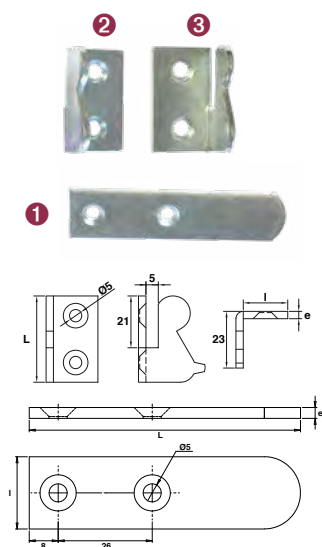

90IX01.. Agrafe picarde

Code		L	l	e		Dispo. (sem.)
1 Plate						
90IX10Z	304L	75	20	3	1	STOCKÉ
2 Gauche						
90IX01Z	304L	35	18	3	1	Nous consulter
3 Droite						
90IX02Z	304L	35	18	3	1	Nous consulter

B0465.. Bras de projection inox

Code sens gauche	Code sens droite		L		Dispo. (sem.)
B0465500	B0465400	BRUT	445	25	STOCKÉ
B046550J	B046540J	9005 - 30%	445	25	STOCKÉ

Bras de projection en inox 304.
1 seule dimension : 445 mm.
Fonctionnement souple et fluide (jeu réduit, rondelle de frottement)
Disponible en inox brut et laqué noir 9005/30.

I349 70.. Gâche trifonction

Code		L	l	H		Dispo. (sem.)
<i>Largeur réglable de 36 à 90 mm</i>						
I349 70 0170	304L	170	90	50	1	4

Robuste, inox épaisseur 4 mm.
Tampon amortisseur. Largeur réglable.