

Equerres, tés

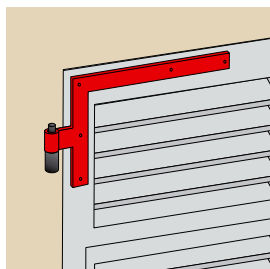

**S9005..** Equerre bout carré  
35x4 Ø14

Code gauche	Code droite			Dispo. (sem.)
S900514Z	S900528Z	316L	1	STOCKÉ
S900514	S900528	316L B	1	STOCKÉ

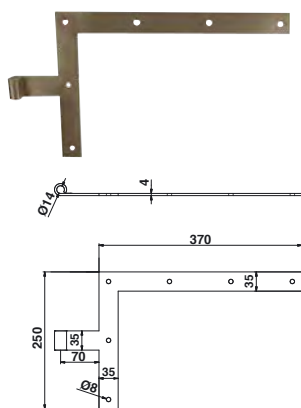
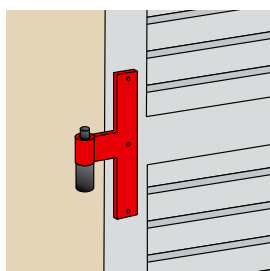
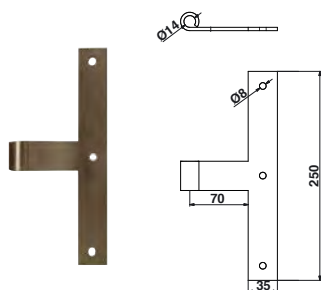

**S90061..** Té de milieu  
35x4 Ø14

Code			Dispo. (sem.)
S900614Z	316L	1	STOCKÉ
S900614	316L B	1	STOCKÉ

Gonds

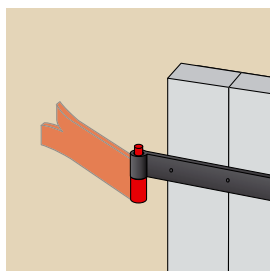
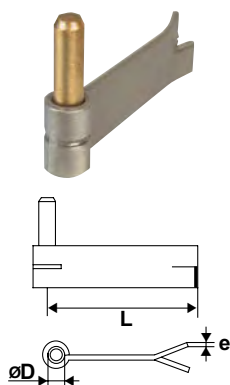

**S90114..** Gond à sceller 1 lame axe laiton

Code		ØD	L	e		Dispo. (sem.)
S901146Z	316L	16	180	5	1	2
S901144	316L B	14	135	4	1	2
S901146	316L B	16	180	5	1	2

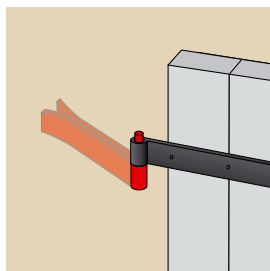
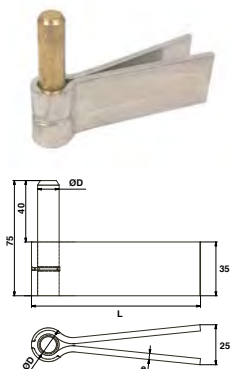

**S90124..** Gond à sceller 2 lames axe laiton

Code		ØD	L	e		Dispo. (sem.)
S901244Z	316L	16	110	4	10	2
S901246Z	316L	16	120	5	1	2
S901244	316L B	14	110	4	1	2
S901246	316L B	14	120	5	1	2