

Persiennes à projection fer

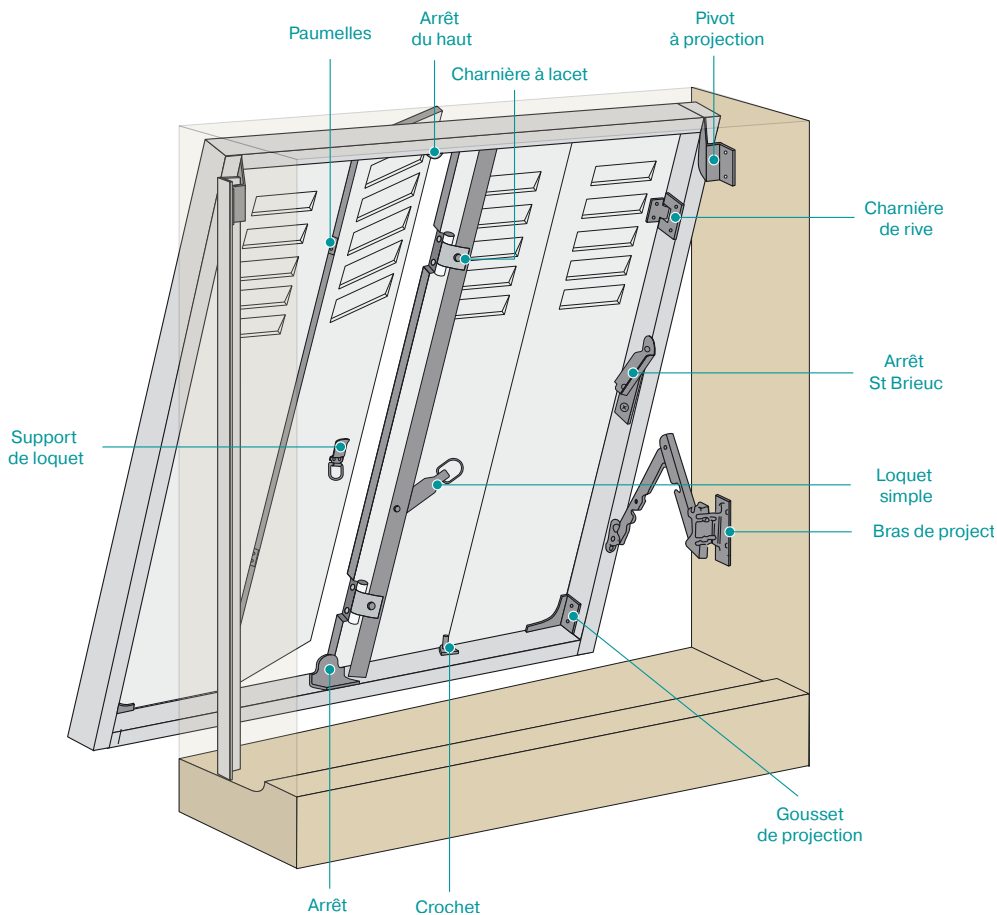

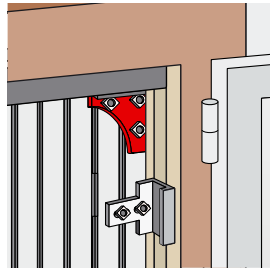
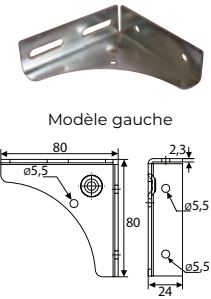

Gousset de projection

Code		Modèle		Dispo. (sem.)
B0065402	Z.BLANC	Gauche	100	1
B0065502	Z.BLANC	Droite	100	1

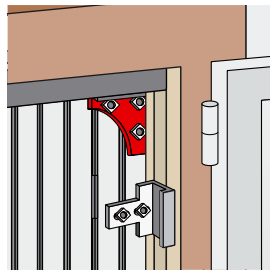
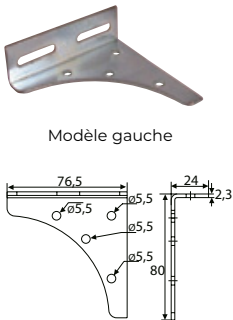

Gousset de projection grugé percé

Code		Modèle		Dispo. (sem.)
B0088103	Z.BLANC	Gauche	100	1
B0088303	Z.BLANC	Droite	100	1

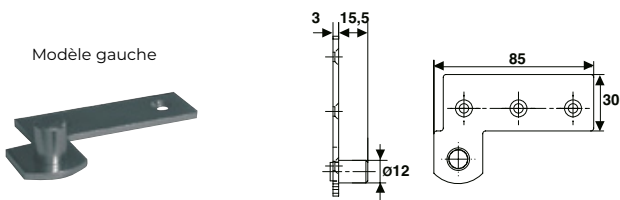

Support tourillon

Code		Modèle		Dispo. (sem.)
B0567603	Z.BLANC	Gauche	125	1
B0567903	Z.BLANC	Droite	125	1

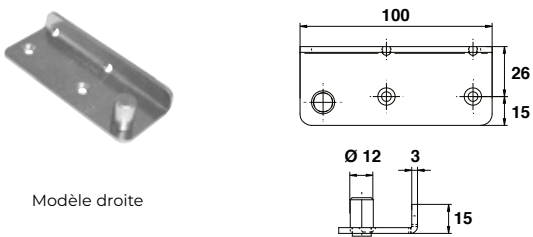

Pivot de projection

Code		Modèle		Dispo. (sem.)
B0761703	Z.BLANC	Gauche	50	1
B0761203	Z.BLANC	Droite	50	1

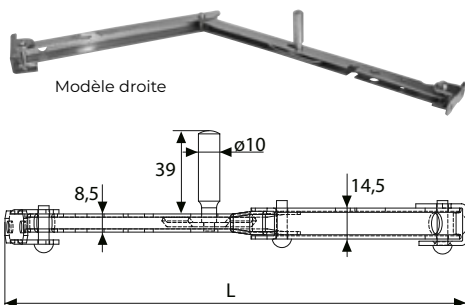

Bras de projection

Code gauche	Code droite		L		Dispo. (sem.)
B0359703	B0359603	Z.BLANC	400	25	1
B0360603	B0360503	Z.BLANC	500	25	1

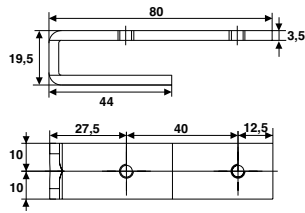

Coussinet réglable

Code			Dispo. (sem.)
B0219202	Z.BLANC	100	NC



1

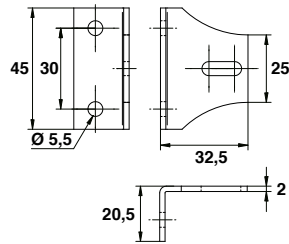

Platine cochonnet

Code			Dispo. (sem.)	U
1 4-6 vantaux				
B0594903	Z.BLANC	300	1	%
2 8-12 vantaux				
B0595003	Z.BLANC	300	1	%



2

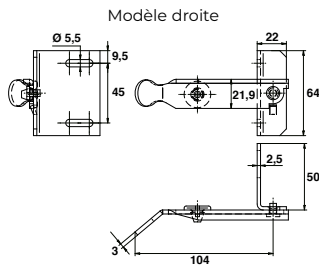
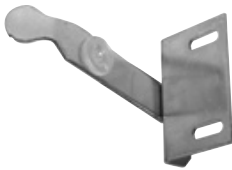
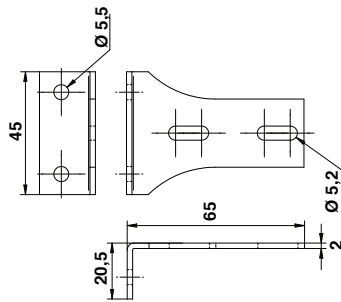

Modèle droite

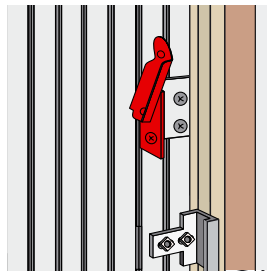

Arrêt sur équerre mortaisée avec butée

Code gauche	Code droite			Dispo. (sem.)	U
B0244803	B0244903	Z.BLANC	50	1	%

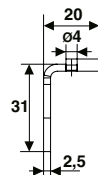

Butée du haut avec entaille

Code			Dispo. (sem.)	U
B0196203	Z.BLANC	500	1	%

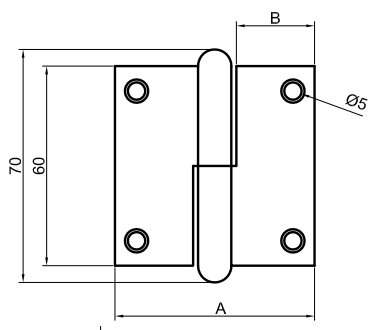
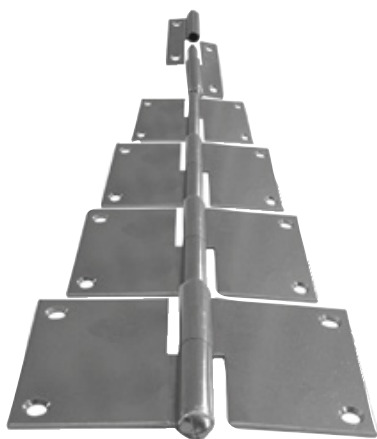

	4 A	6 A	8 A	10 A	12 A
A	38	60	76	95,6	115,6
B	12,5	23,5	31,5	39,8	49,8

Paumelles 4 vantaux

Code gauche	Code droite			Dispo. (sem.)	U
Mâle					
J1104G0	J1104D0	304L	250	1	%
Femelle					
J2104G0	J2104D0	304L	250	1	%

Paumelles 6 vantaux

Code gauche	Code droite			Dispo. (sem.)	U
Mâle					
J1106G0	J1106D0	304L	200	1	%
Femelle					
J2106G0	J2106D0	304L	200	1	%

Paumelle 8 vantaux

Code gauche	Code droite			Dispo. (sem.)	U
Mâle					
J1108G0	J1108D0	304L	100	1	%
Femelle					
J2108G0	J2108D0	304L	100	1	%

Paumelle 10 vantaux

Code gauche	Code droite			Dispo. (sem.)	U
J538570	J538560	304L	25	4	

Paumelle 12 vantaux

Code gauche	Code droite			Dispo. (sem.)	U
J538590	J538580	304L	25	4	

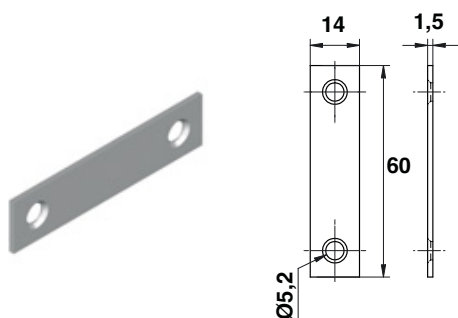

Contre-rivure

Code			Dispo. (sem.)	U
B0714900	304L	1000	1	%

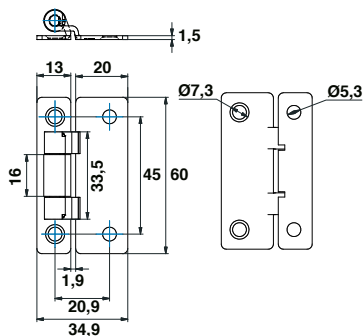

Charnière de rive montée

Code			Dispo. (sem.)	U
B0240360	304L	250	1	%

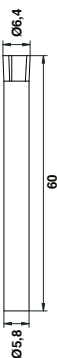

Broche

Code			Dispo. (sem.)	U
B0714200	304L	500	1	%

1

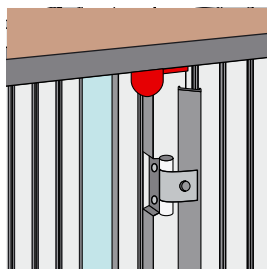
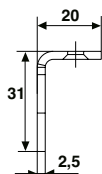

2

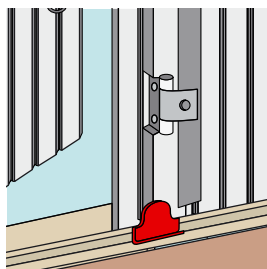
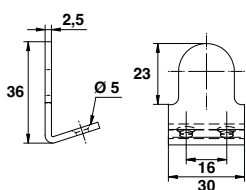

Butée

Code			Dispo. (sem.)	U
1 Modèle haut				
B0734900	304L	500	1	%
2 Modèle bas				
B0571200	304L	250	1	%

1

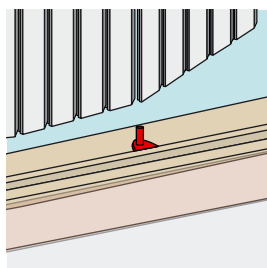
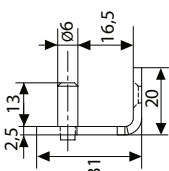

2

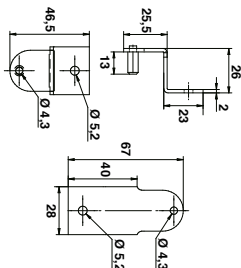

Crochet de rappel

Code			Dispo. (sem.)
1 B0735000	304L	500	1
2 B0567500	304L	250	NC

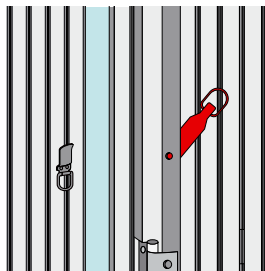
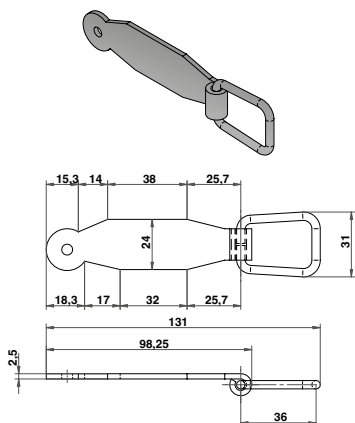

Loquet monté sans oreillon

Code			Dispo. (sem.)
B0731500	304L	100	4

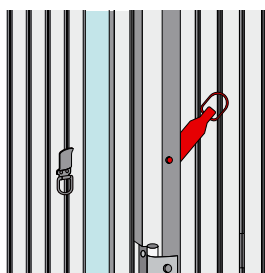
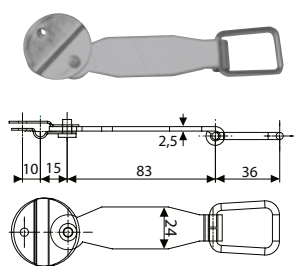

Loquet monté avec oreillon

Code			Dispo. (sem.)
B0731400	304L	100	1

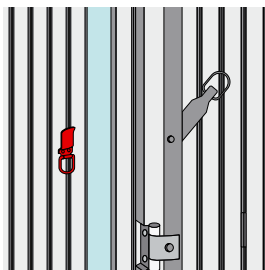
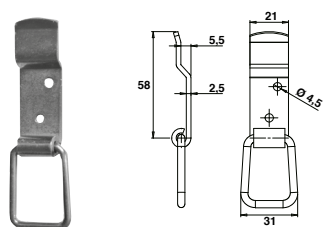

Support loquet 2 trous



Code			Dispo. (sem.)
B0734800	304L	200	1

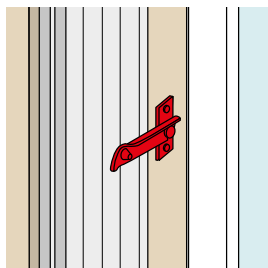
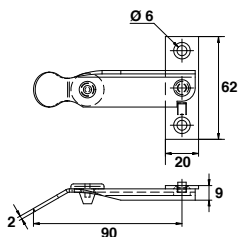

Modèle gauche



Arrêt St Briec avec butée

Code		Modèle		Dispo. (sem.)
BF244500	304L	Gauche	100	1
BF244400	304L	Droite	100	1

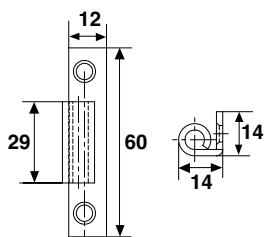

Charnière de rive mâle non montée

Code	304L	250	Dispo. (sem.)
J539250	304L	250	1

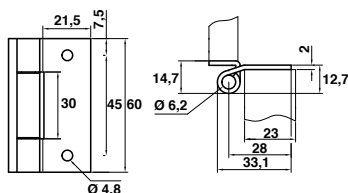

Charnière de rive femelle cambrée non montée

Code	304L	250	Dispo. (sem.)
J539270	304L	250	1

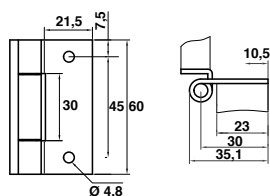

Charnière de rive femelle non montée

Code	304L	250	Dispo. (sem.)
J539280	304L	250	1

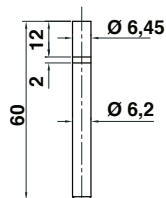

Broche

Code	304L	500	Dispo. (sem.)	U
J546820	304L	500	1	%

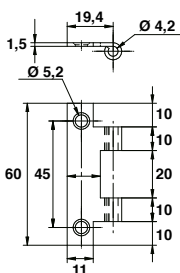
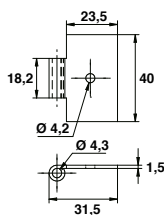

Charnière à lacet

Code	304L	Modèle	Dispo. (sem.)	U
1 B0835300	304L	Mâle	500	4 %
2 B0922800	304L	Femelle	500	1 %

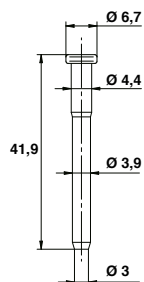

Broche inox

Code	304L	1000	Dispo. (sem.)	U
B0002336	304L	1000	1	%