

Equerres, tés

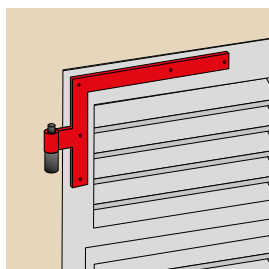

S9005.. Equerre bout carré  
35x4 Ø14

Code gauche	Code droite		Tarif HT en €		Dispo. (sem.)
S900514	S900528	316L B	68,30	1	STOCKÉ
S900514Z	S900528Z	316L P	62,82	1	STOCKÉ

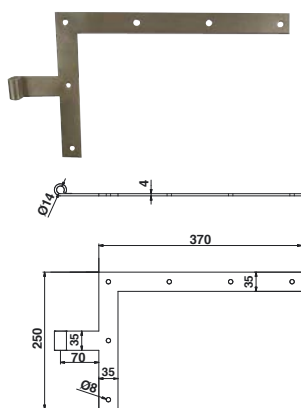
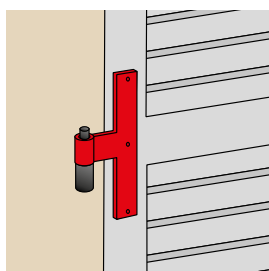
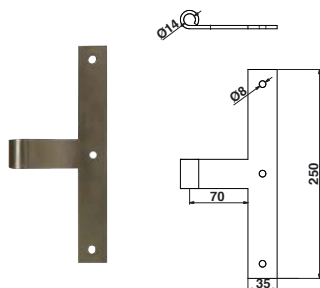

S90061.. Té de milieu  
35x4 Ø14

Code		Tarif HT en €		Dispo. (sem.)
S900614	316L B	41,79	1	STOCKÉ
S900614Z	316L P	38,44	1	STOCKÉ

Gonds

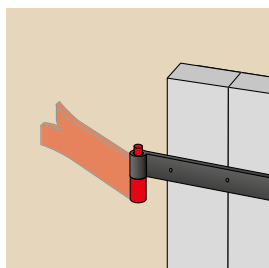
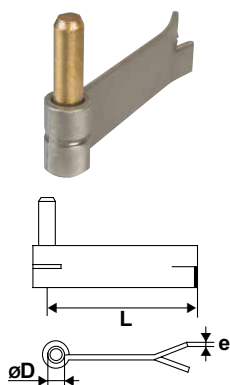

S90114.. Gond à sceller 1 lame axe laiton

Code		L	ØD	e	Tarif HT en €		Dispo. (sem.)
S901144	316L B	135	14	4	Nous consulter	1	2
S901146	316L B	180	16	5		1	2
S901146Z	316L P	180	16	5		1	2

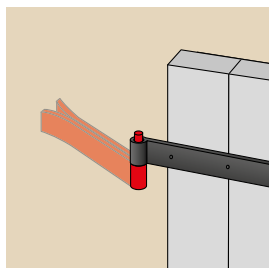
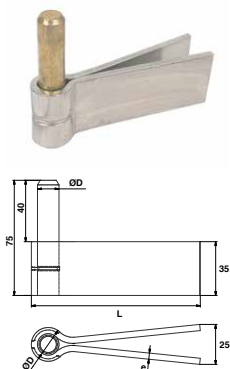

S90124.. Gond à sceller 2 lames axe laiton

Code		ØD	L	e	Tarif HT en €		Dispo. (sem.)
S901244Z	316L P	14	110	4	28,41	10	STOCKÉ
S901246Z	316L P	16	120	5	30,87	1	STOCKÉ

Code		ØD	L	e	Tarif HT en €		Dispo. (sem.)
S901244	316L B	14	110	4	Nous consulter	1	2
S901246	316L B	16	120	5	Nous consulter	1	2

Gonds

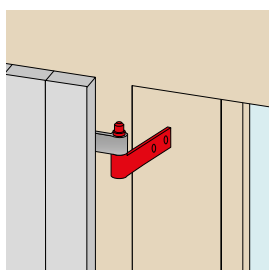
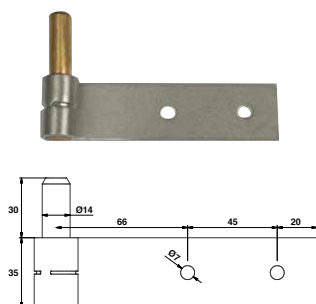
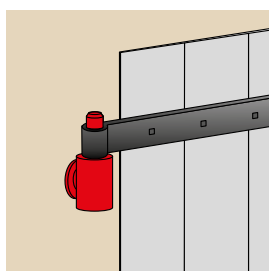
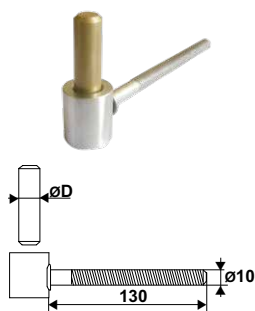
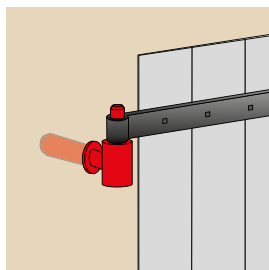
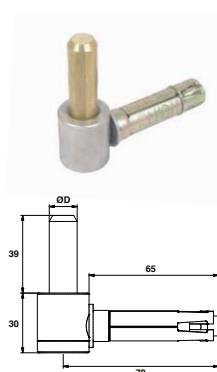
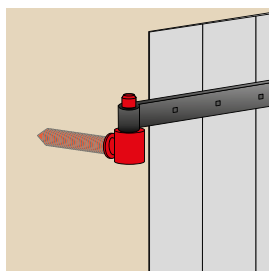
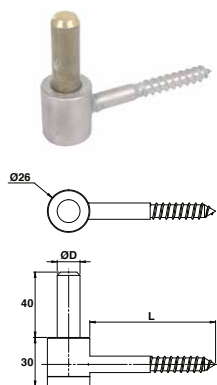

S90041.. Gond vis bois axe laiton

Code		ØD	L	Tarif HT en €		Dispo. (sem.)
S900414	316L B	Ø14	80	34,97	10	STOCKÉ
S900414Z	316L P	Ø14	80	32,18	1	STOCKÉ
S900416	316L B	Ø16	80	38,09	1	STOCKÉ
S900417Z	316L P	Ø14	107	36,02	1	STOCKÉ

Code		ØD	L	Tarif HT en €		Dispo. (sem.)
S901244	316L B	14	107	Nous consulter	1	2

S90141.. Gond vis métaux + cheville axe laiton

Code		ØD	Tarif HT en €		Dispo. (sem.)
S901414	316L B	Ø14	40,13	10	STOCKÉ
S901414Z	316L P	Ø14	40,13	10	STOCKÉ

Code		ØD	Tarif HT en €		Dispo. (sem.)
S901416	316L B	Ø16	Nous consulter	1	Nous consulter
S901416Z	316L P	Ø16	consulter	1	2

61IX1.. POLYGOND® axe laiton

Code		ØD	Tarif HT en €		Dispo. (sem.)
61IX14PB	316L B	Ø14	32,27	10	STOCKÉ
61IX14Z	316L P	Ø14	29,68	10	STOCKÉ
61IX16PB	316L B	Ø16	34,32	10	STOCKÉ

Code		ØD	Tarif HT en €		Dispo. (sem.)
61IX16Z	316L P	Ø16	Nous consulter	10	4

S901088Z Gond à patte 35x4 Ø14 axe laiton

Code		Tarif HT en €		Dispo. (sem.)
S901088Z	316L P	22,72	10	STOCKÉ

## Gonds

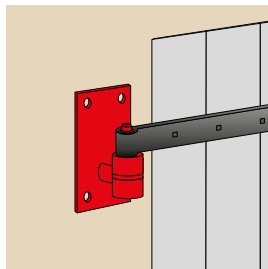
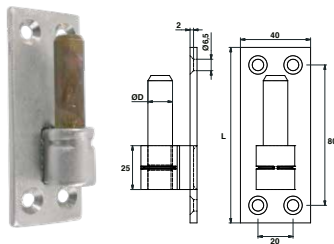

### S90131.. Gond sur plaque axe laiton

Code		L	ØD	Tarif HT en €		Dispo. (sem.)
S901314	316L B	100	Ø14	36,95	1	STOCKÉ
S901314Z	316L P	100	Ø14	34,00	1	STOCKÉ
S901316Z	316L P	180	Ø16	51,70	10	STOCKÉ

Code		L	ØD	Tarif HT en €		Dispo. (sem.)
S901316	316L B	180	Ø16	Nous consulter	1	4

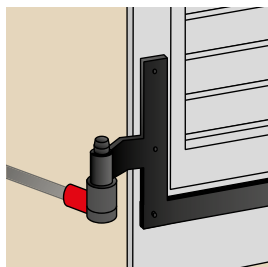
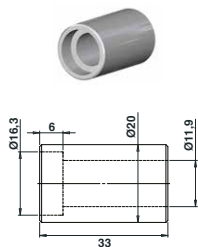

### S900450 Entretoise

Code		L	Tarif HT en €		Dispo. (sem.)
S900450	316L	5,07	150		STOCKÉ

## Tourniquets

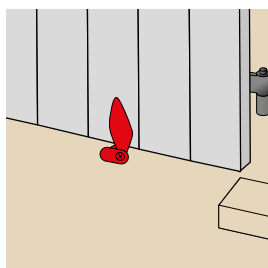

### S90151.. Tourniquet marseillais à vis tête forgée

Code		L	Tarif HT en €		Dispo. (sem.)
S901513	316L B	130	37,58	1	STOCKÉ
S901513Z	316L P	130	34,56	10	STOCKÉ

Code		L	Tarif HT en €		Dispo. (sem.)
S901510	316L B	110		1	2
S901510Z	316L P	110	Nous	10	2
S901518	316L B	180	consulter	10	2
S901518Z	316L P	180		10	2

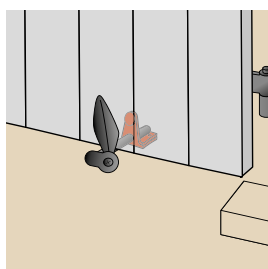
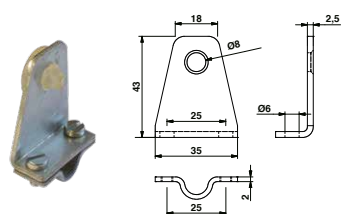

### S901525 Butée pour tourniquet marseillais Ø10

Code		L	Tarif HT en €		Dispo. (sem.)
S901525	316L P	15,29	1		STOCKÉ